

BERNARDO ROBERTO MORAY S.
 ARQUITECTO
 REG. PROF. N° 1544
 RUC: 1238923-3
 TEL: 0981-48551

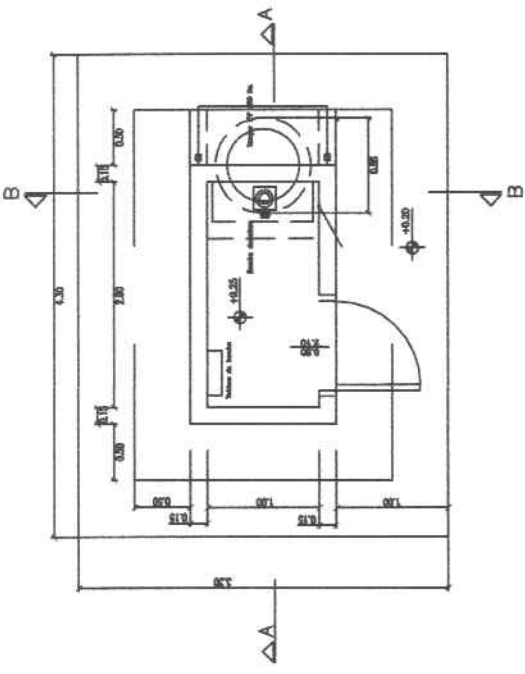

PLANTA DE CASETA

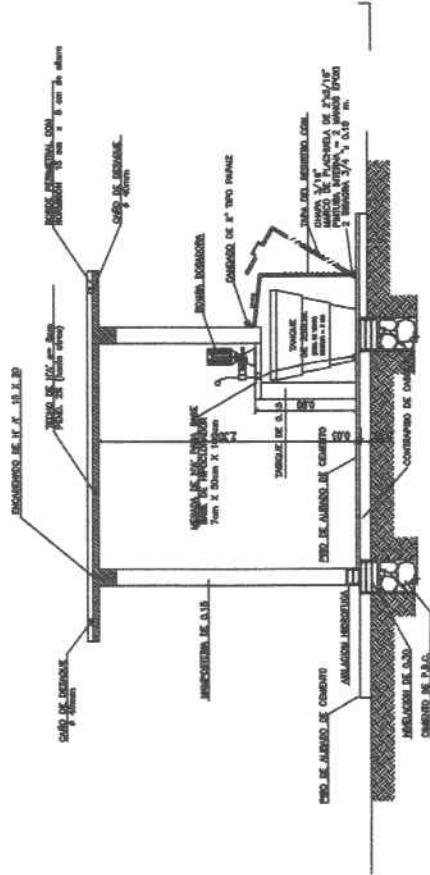

CORTE AA

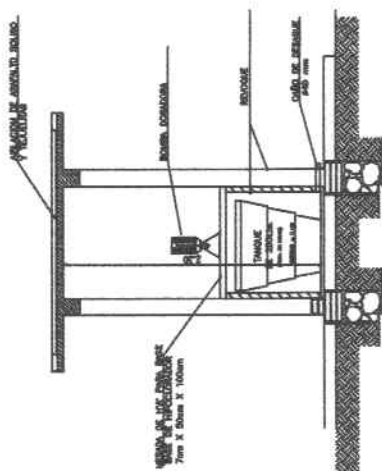

CORTE BB

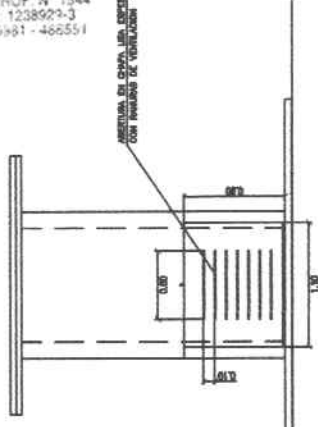

FACHADA LATERAL

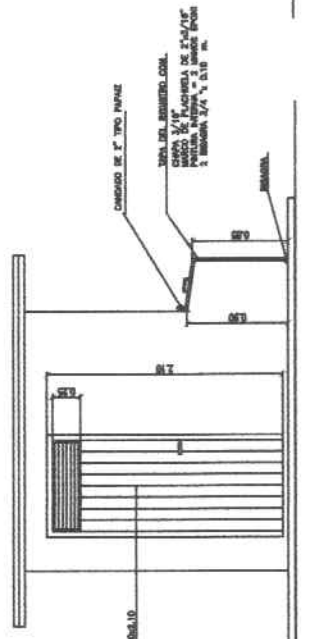

FACHADA FRONTAL

DEPARTAMENTO: OBRAS.

DIVISION: PROYECTOS

OBRA

PLANO Sin Esc.

AÑO

Construcción de Caseta de Mando

PLANO N°

01

PLANTA DE CASETA

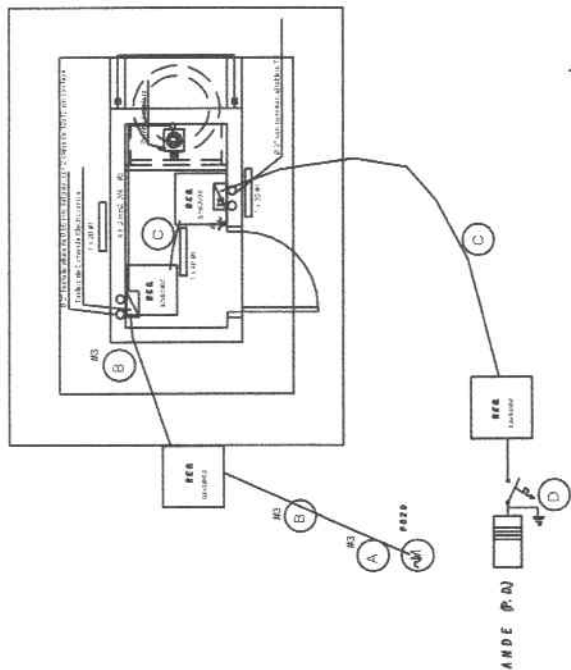

INSTALACION TRIFASICA

A	B	C	D	E
1-2 HP	3 X 4 - 2"	3 X 4 + 12.4 - 2"	15 A	15 A
3-5 HP	3 X 4 - 2"	3 X 6 + 12.4 - 2"	20 A	20 A
7.5 HP	3 X 6 - 2"	3 X 6 + 12.4 - 2"	20 A	25 A
10 HP	3 X 6 - 2"	3 X 6 + 12.4 - 2"	25 A	32 A
12.5 HP	3 X 6 - 2"	3 X 6 + 12.4 - 2"	25 A	32 A
15 HP	3 X 6 - 2"	3 X 6 + 12.4 - 2"	25 A	32 A
20 HP	3 X 10 - 2"	3 X 10 + 12.4 - 2"	40 A	40 A
25 HP	3 X 10 - 2"	3 X 10 + 12.4 - 2"	50 A	50 A
30 HP	3 X 16 - 2"	3 X 25 + 12.4 - 2"	63 A	63 A

INSTALACION MONOFASICA

A	B	C	D	E
1 HP	3 X 4 - 2"	2 X 6 - 2"	15 A	15 A
2 HP	3 X 4 - 2"	2 X 6 - 2"	20 A	20 A
3 HP	3 X 4 - 2"	2 X 6 - 2"	20 A	20 A
5 HP	3 X 16 - 2"	2 X 10 - 2"	35 A	35 A

Nota 1: Los valores (A), (B), (C), (D) están indicados en el cuadro adjunto y dependen de la potencia de la bomba.
 Nota 2: Los ductos en los registros internos en la caseta deben entrar a través de curvas largas de 2'.

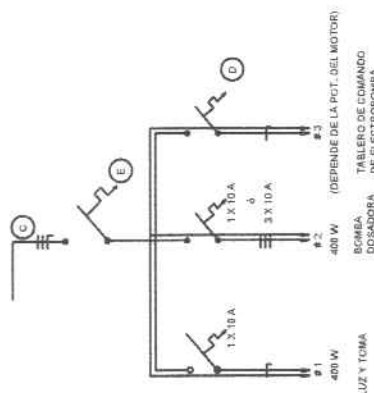

 BERNARDO ROBERTO MORAY S.
 ARQUITECTO
 REG. PROF. N° 1544
 RUC. 1238927-3
 TEL. 0981 - 466551



SELECCION DE CABLES

SECCION	TIPO	SECCION	TIPO
1	1	2	2
3	3	4	4
5	5	6	6
7	7	8	8
9	9	10	10
11	11	12	12
13	13	14	14
15	15	16	16
17	17	18	18
19	19	20	20
21	21	22	22
23	23	24	24
25	25	26	26
27	27	28	28
29	29	30	30
31	31	32	32
33	33	34	34
35	35	36	36
37	37	38	38
39	39	40	40
41	41	42	42
43	43	44	44
45	45	46	46
47	47	48	48
49	49	50	50
51	51	52	52
53	53	54	54
55	55	56	56
57	57	58	58
59	59	60	60
61	61	62	62
63	63	64	64
65	65	66	66
67	67	68	68
69	69	70	70
71	71	72	72
73	73	74	74
75	75	76	76
77	77	78	78
79	79	80	80
81	81	82	82
83	83	84	84
85	85	86	86
87	87	88	88
89	89	90	90
91	91	92	92
93	93	94	94
95	95	96	96
97	97	98	98
99	99	100	100

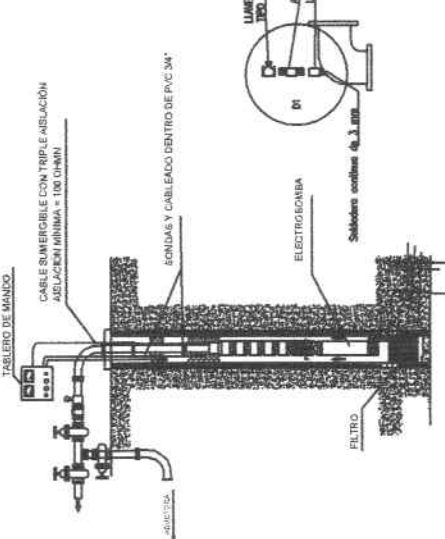
DETALLE DE INSTALACION DE ELECTROBOMBA



DETALLE DE CABALLETE

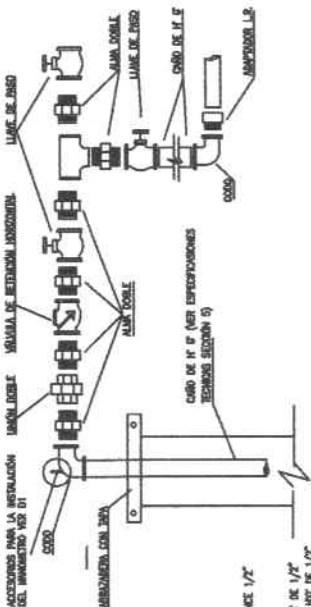

DEPARTAMENTO: OBRAS.

DIVISION: PROYECTOS

PLANO OBRA

Sin Esc.

AÑO

Detalle de Electrobomba.

PLANO N°

01

 BERNARDO ROBERTO MORAY S.
 ARQUITECTO
 REG. PROF. N° 1544
 RUC: 1238929-3
 TEL: 0981 - 486551

ESQUEMA DE INSTALACION ELECTROBOMBA SUMERGIBLE

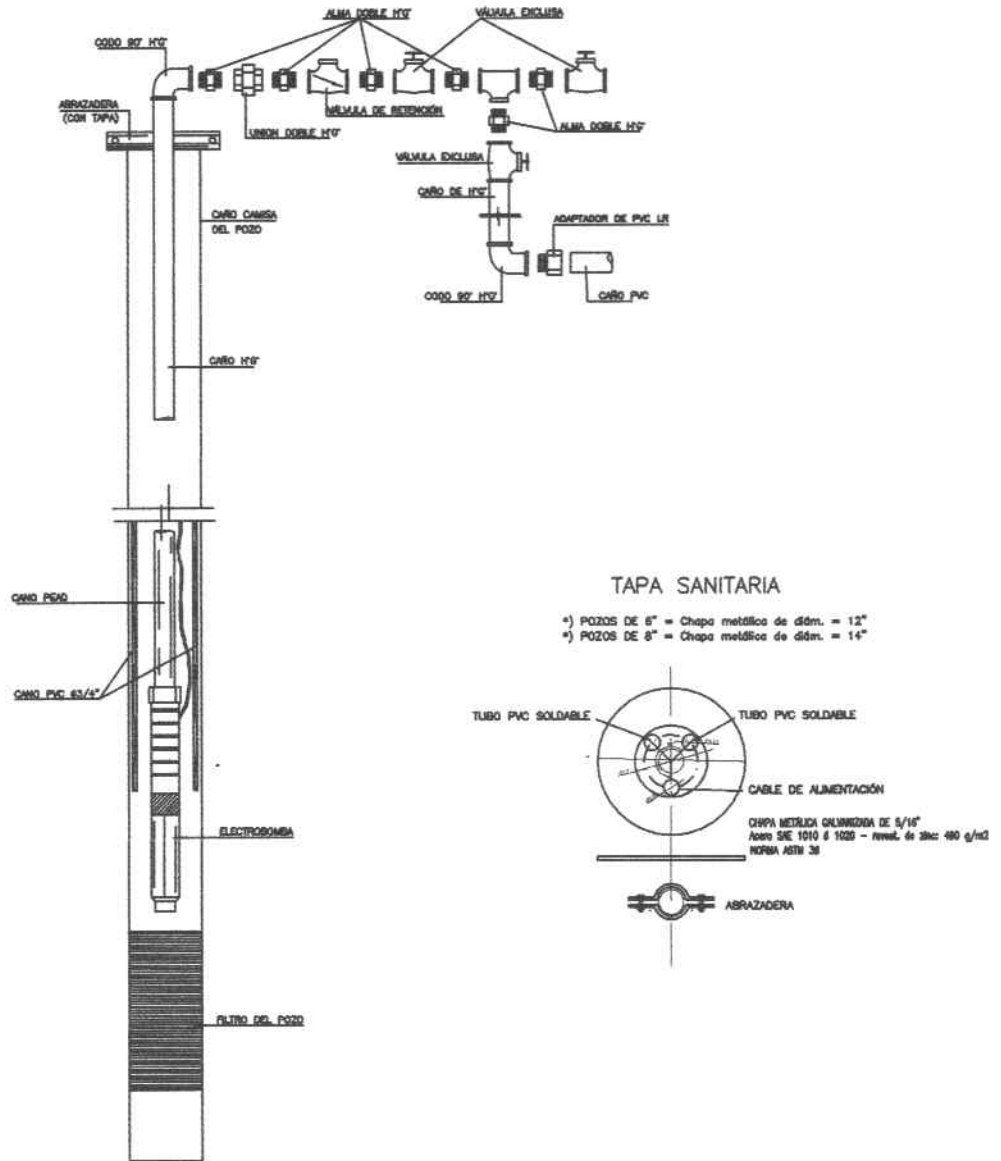

DEPARTAMENTO:	OBRAS.
DIVISION:	PROYECTOS

PLANO Sin Esc.	OBRA Detalle de Instalación Electrobomba sumergible	PLANO N° 01
AÑO		